

Varenummer: 2031120M20125B1U

Beskrivelse: E+G Justerfod
GN 31-120-M20-125-B1-U

Note: U Uden møtrik, sekskant i toppen, spændeflade i bunden

Mål

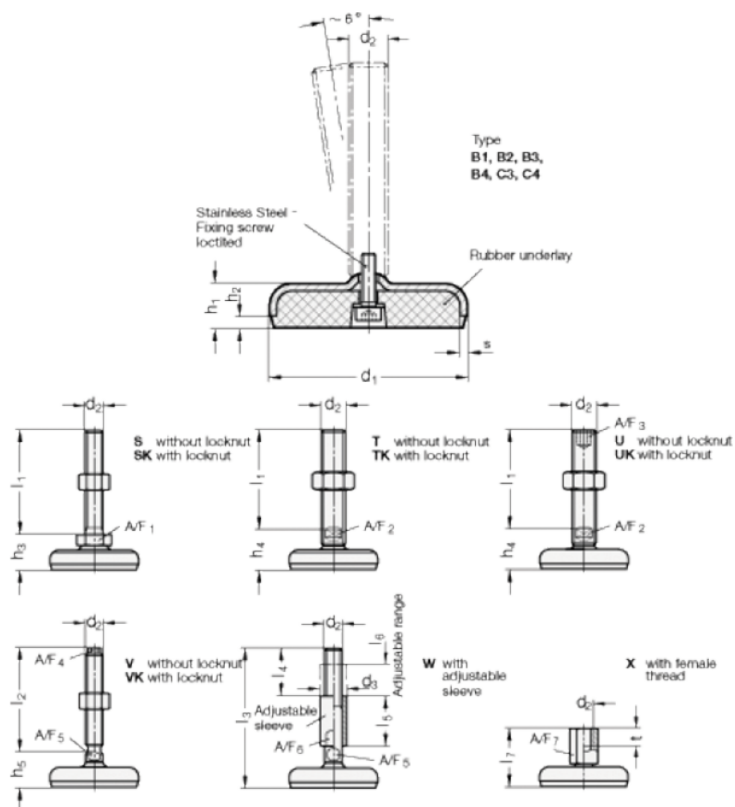

A/F2	= 15	s = 4
A/F3	= 10	
d1	= 120	
d2	= 20	
h1	= 22	
h4 +4.0/0	= 39	
l1	= 125	